

Varenummer: 390204902472236
 Beskrivelse: Snekkegear med skridnav
 VF 49-L2-P-24 P63B5

Mål

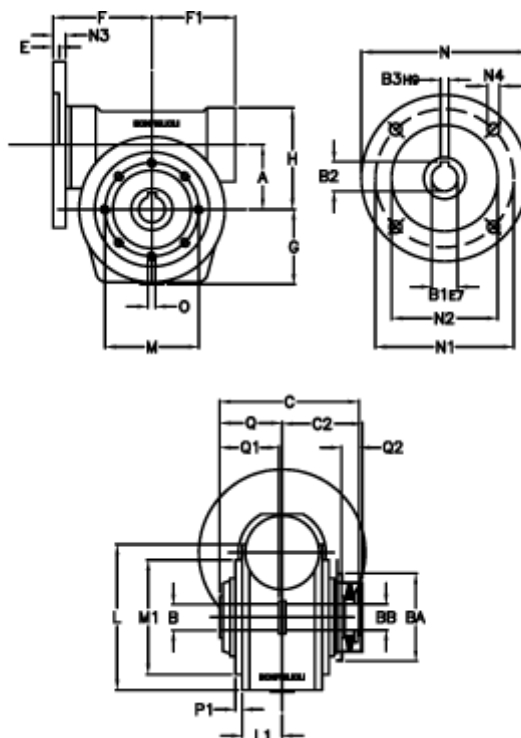

a	= 49.50	C	= 105	L1	= 36.8	O	= M6x8
B	= 25	C2	= 63,5	m	= 94	P1	= 2.5
B1 E7	= 11	E	= 3.0	M1	= 68	Q	= 51.0
B2	= 12.8	F	= 70	N	= 140	Q1	= 41
B3 H9	= 4	F1	= 63	N1	= 115	Q2	= 15
BA	= 63	g	= 56	N2	= 95		
BB H7	= 14	H	= 80.0	N3	= 10.5		
Betegnelse = VF 49P-xx-63B5		L	= 107.5	N4	= 9,5		